



Airplane Rescue

Model 10

Source : Plan et images de LEGO Education
Modification et bonification des plans par le Service national du RÉCIT à l'éducation préscolaire
Translation: LEARN-RÉCIT
February 2012

Airplane Rescue, Model 10

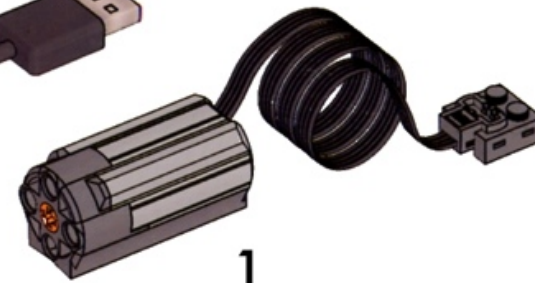
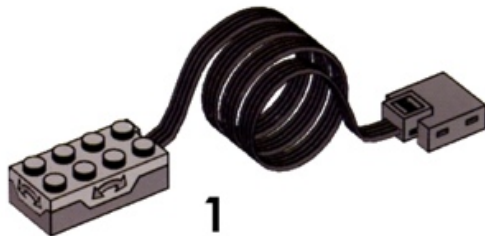
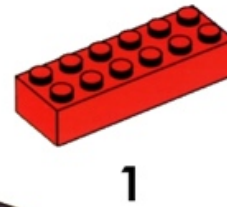
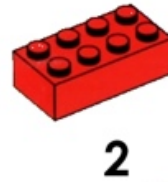
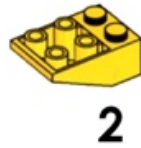
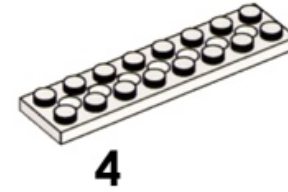
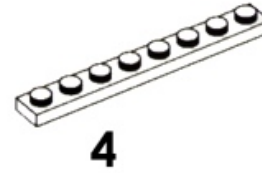
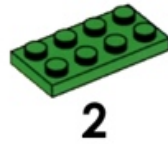
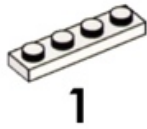
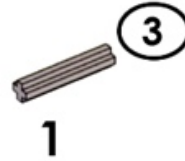

1 axle, 3-module

1 gear, 24-tooth

1 motor

1 round brick
2 X 2

2 plates
2 X 4



1

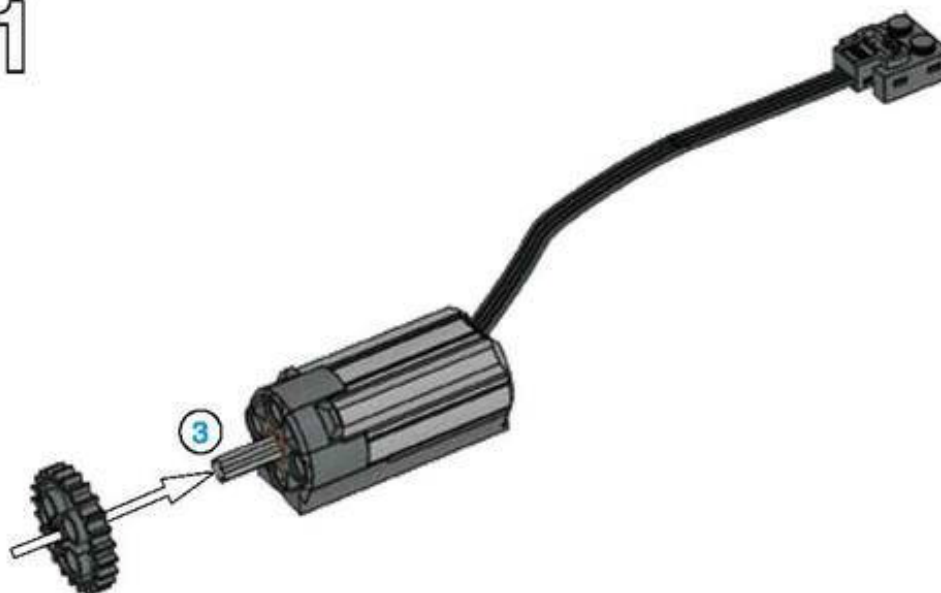

2

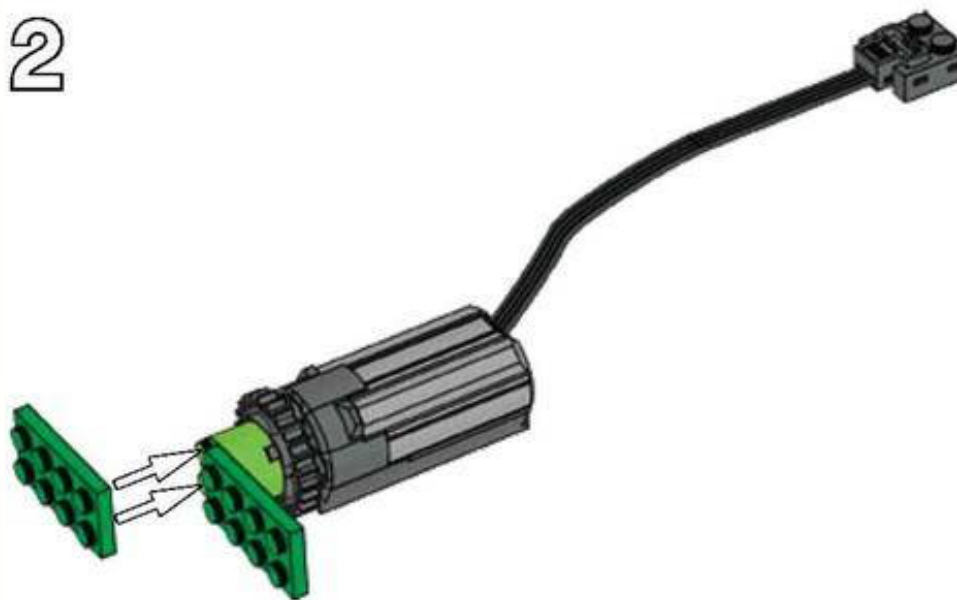

1 USB hub

1 tilt sensor

1 plate
2 X 8

1 plate
1 X 4



3

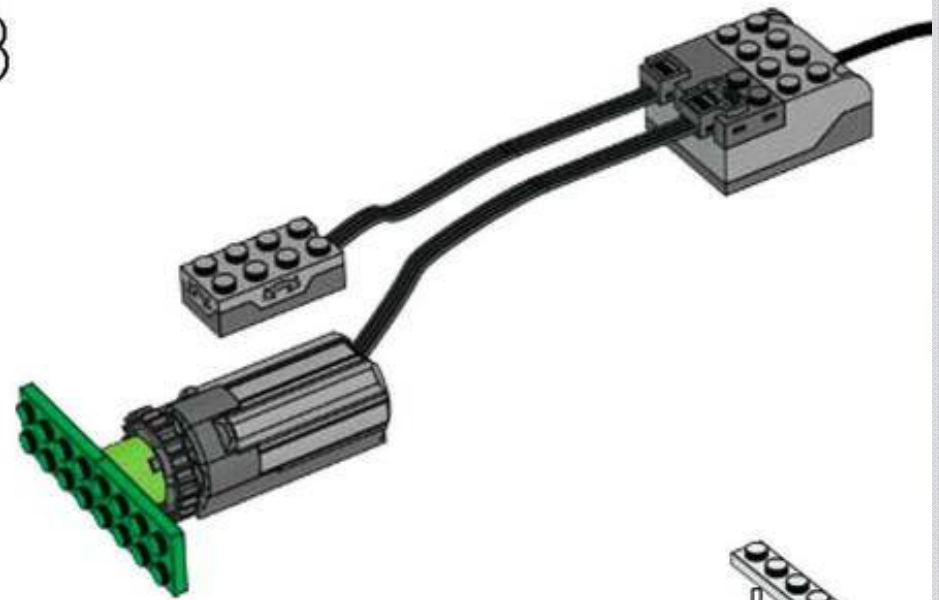

4

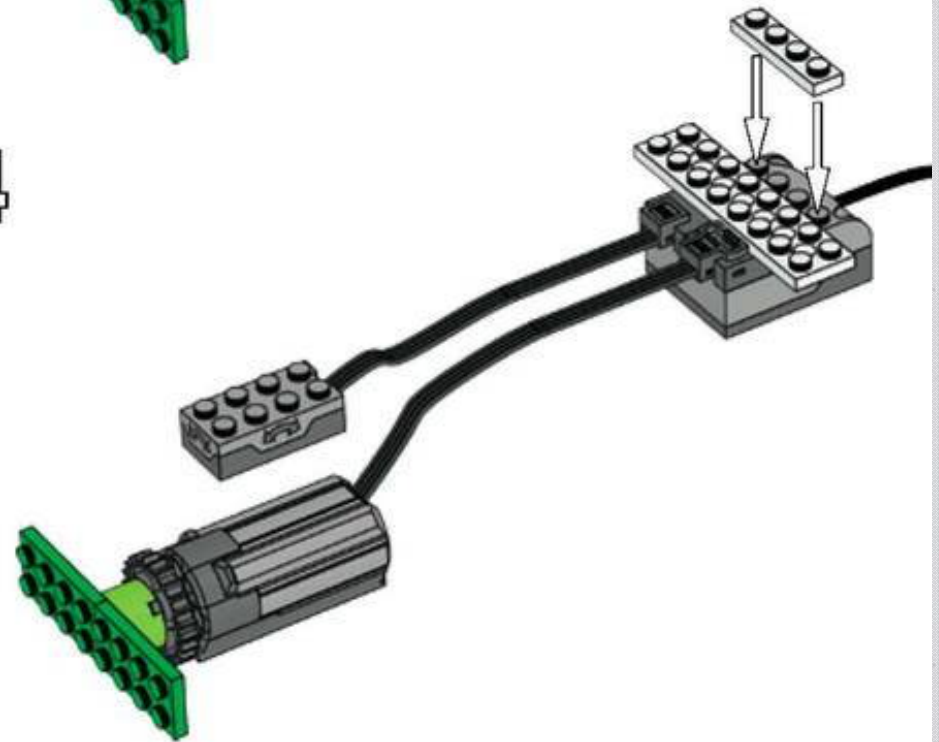

5



6

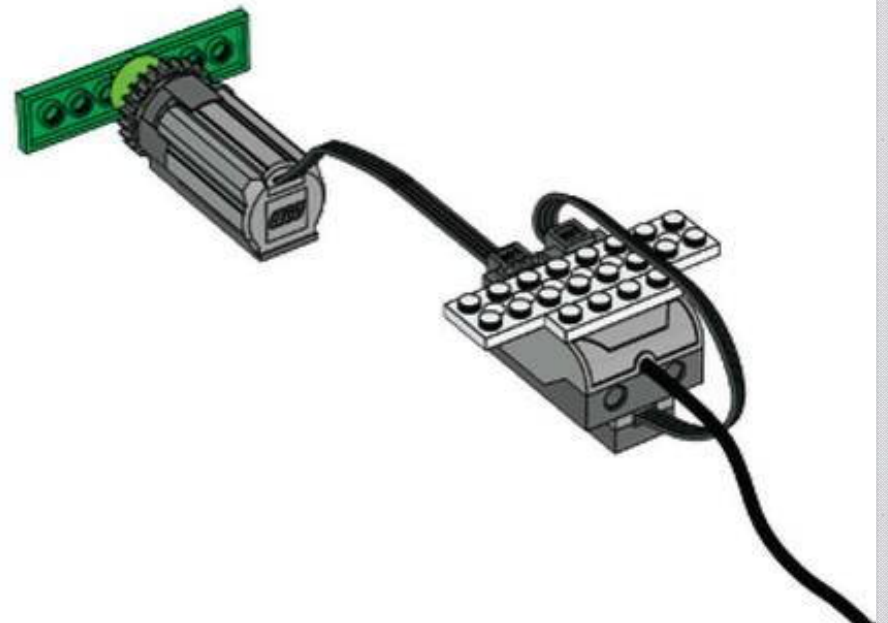

7

2 plates
1 X 8

2 yellow roof bricks,
inverted
2 X 2

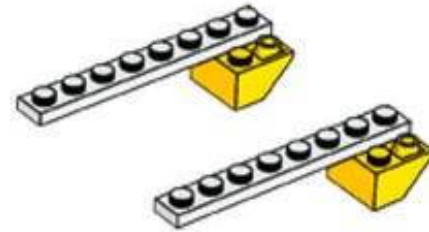
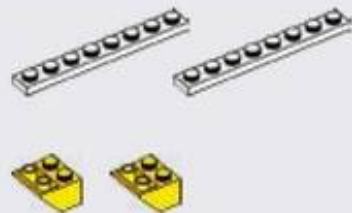

8

2 yellow bricks
2 X 2

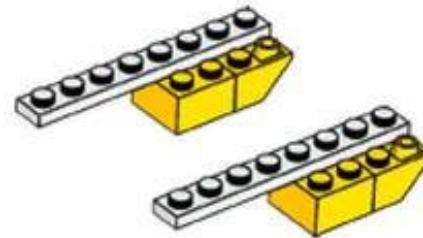

2 yellow roof bricks
inverted
2 X 3

2 yellow beams
1 X 2

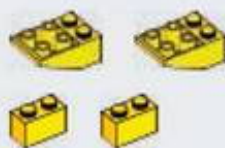

9

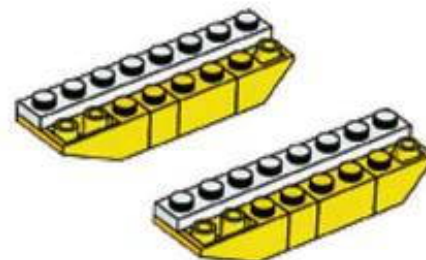

10

2 plates
1 X 8

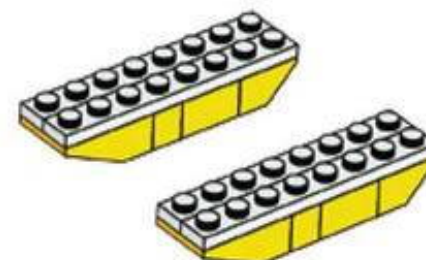

11

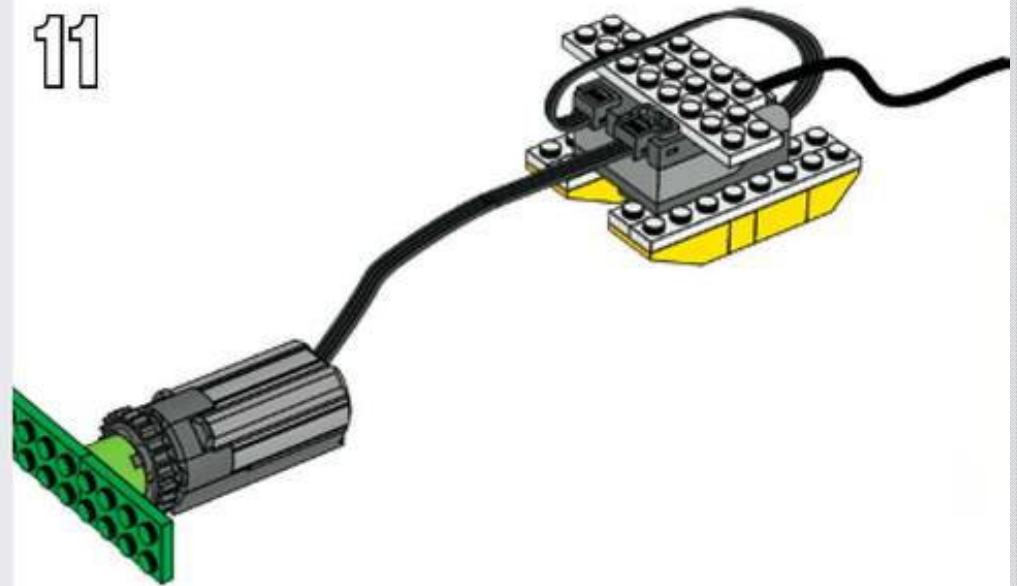
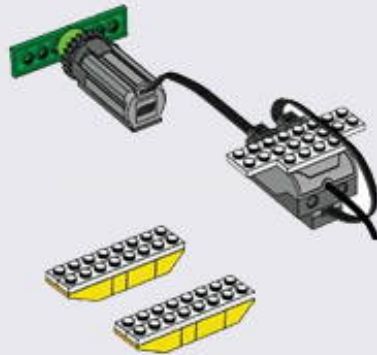

12

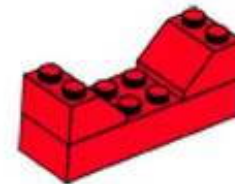

2 red roof bricks
2 X 2



1 red brick
2 X 6



13

1 plate
2 X 6

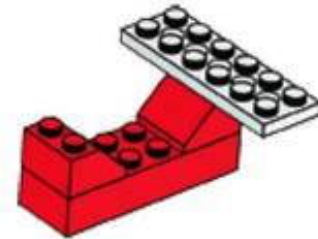

14

1 plate
2 X 8

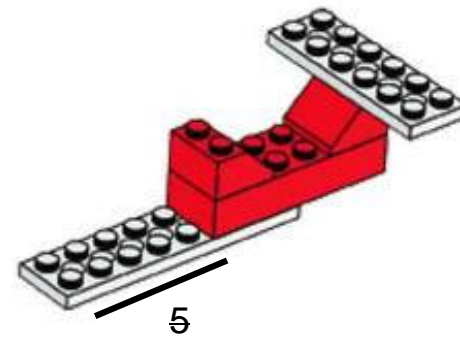

15

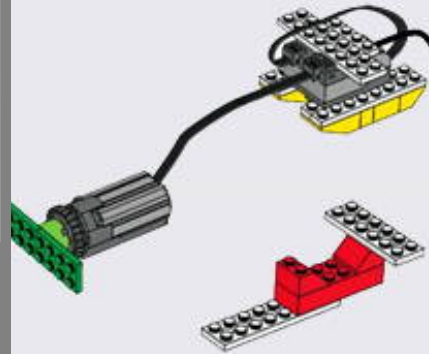

16

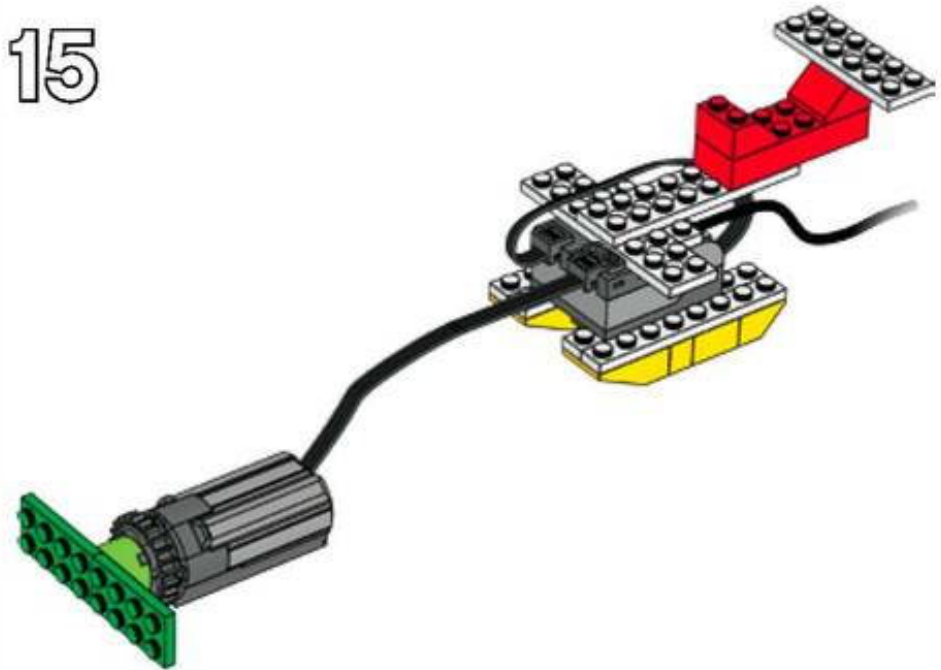

1 red brick 2 X 4



1 plate 2 X 6



1 plate 2 X 8

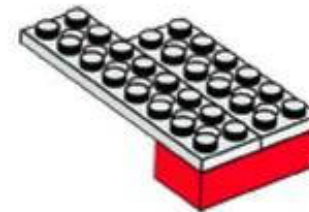

17

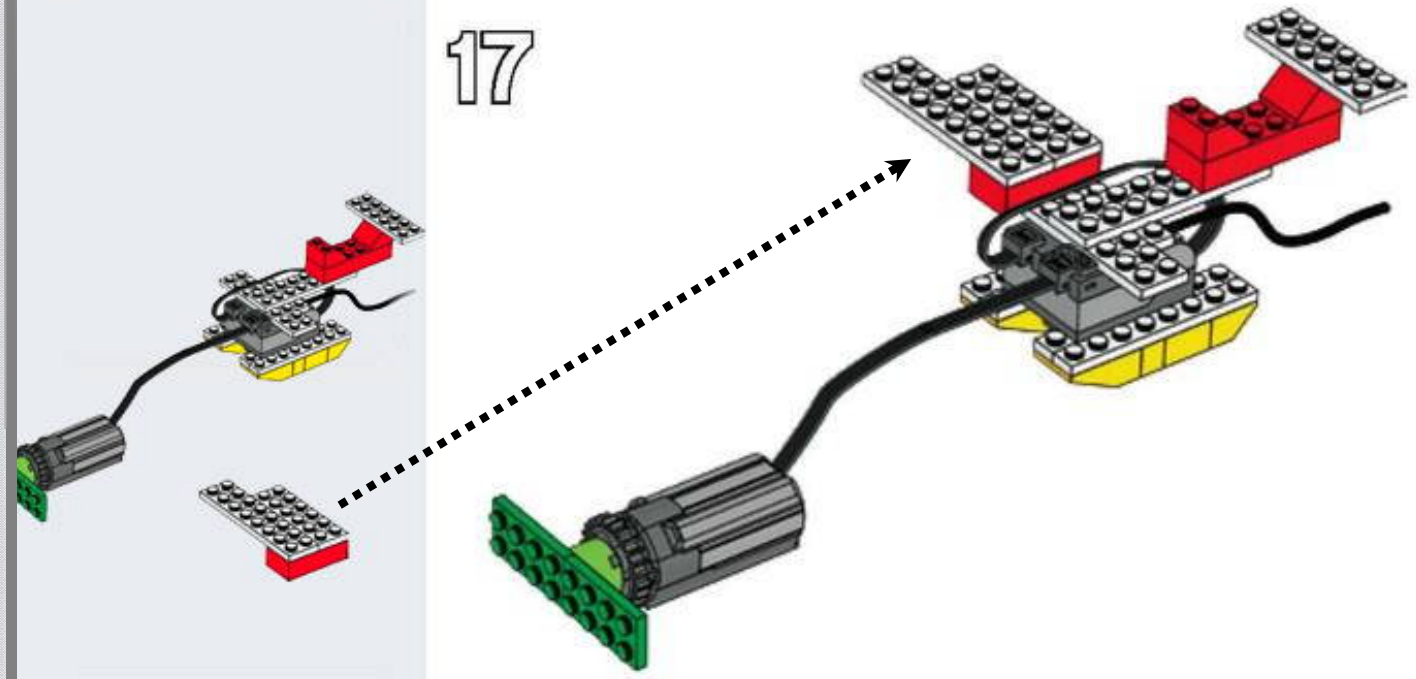

18

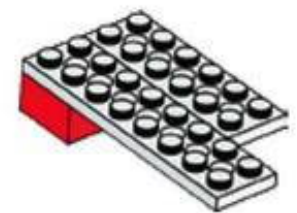

1 red brick 2 X 4



1 plate 2 X 6



1 plate 2 X 8



19

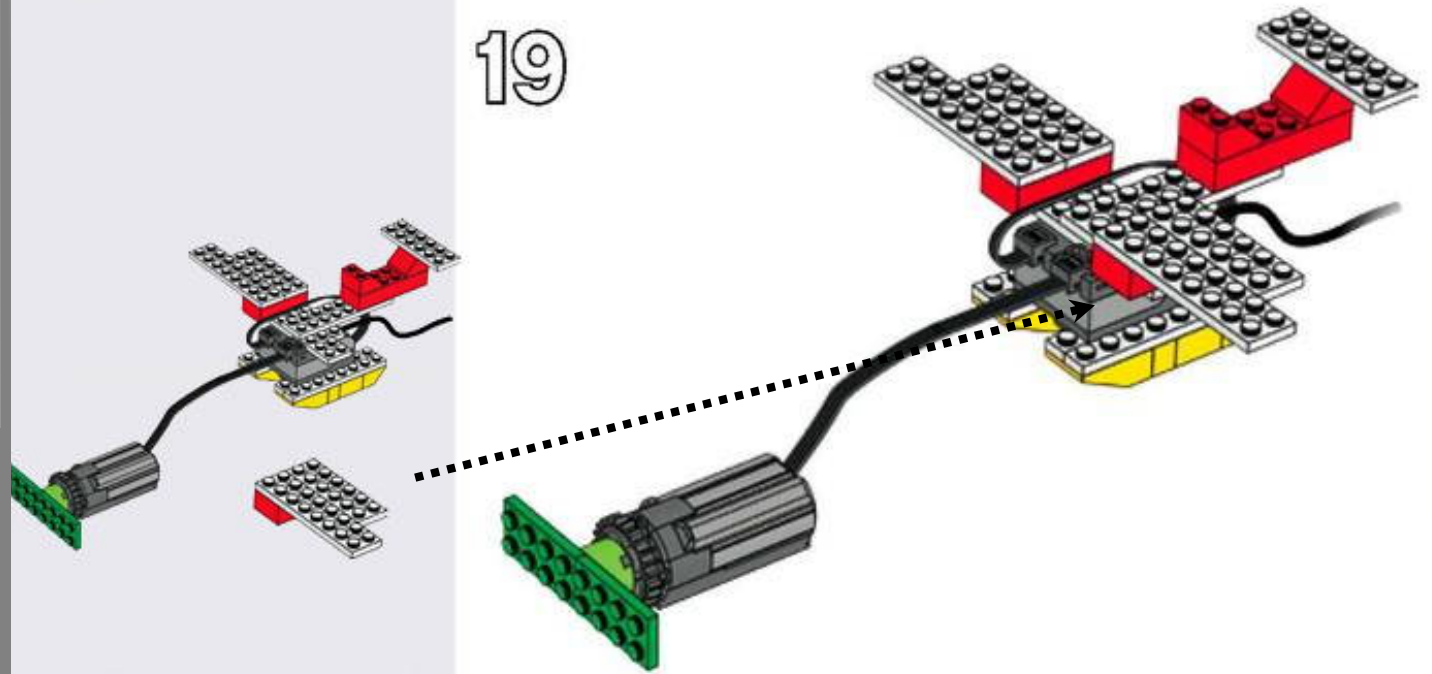

20



1 boy-figure

Well
Done!



21

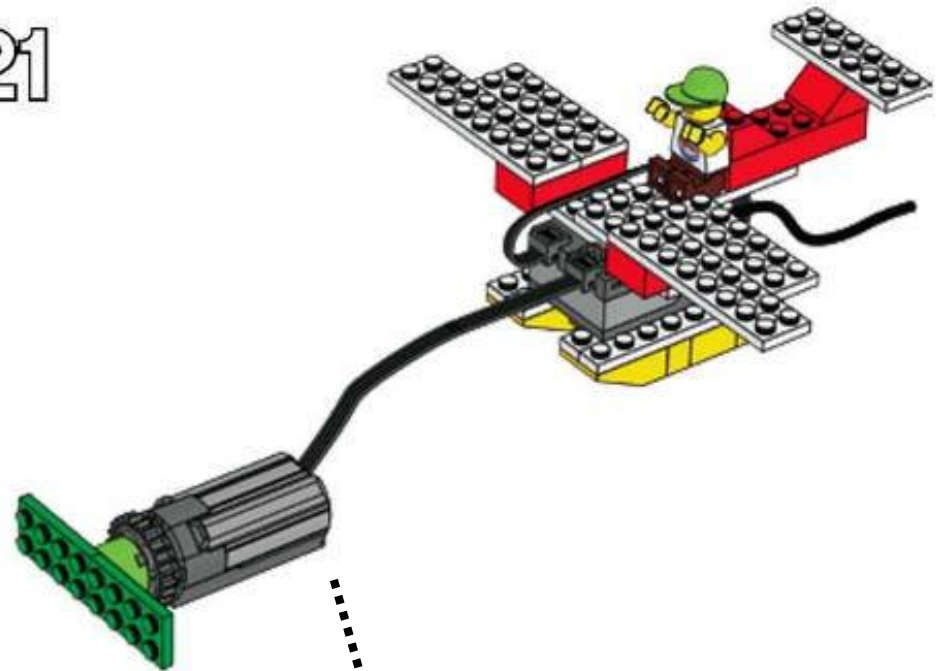

22

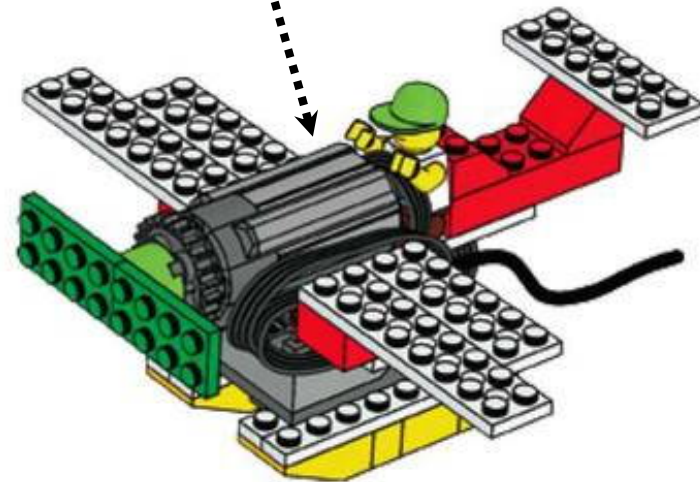

LEGO, the LEGO logo and WEDO are trademarks of the/son des marques de commerce de/son marcas registradas de LEGO Group. ©2008 The LEGO Group.