



Sailboat Storm

Model 12

Source : Plan et images de LEGO Education
Modification et bonification des plans par le Service national du RÉCIT à l'éducation préscolaire
Translation: LEARN-RÉCIT
February 2012

Sailboat Storm, Model 12

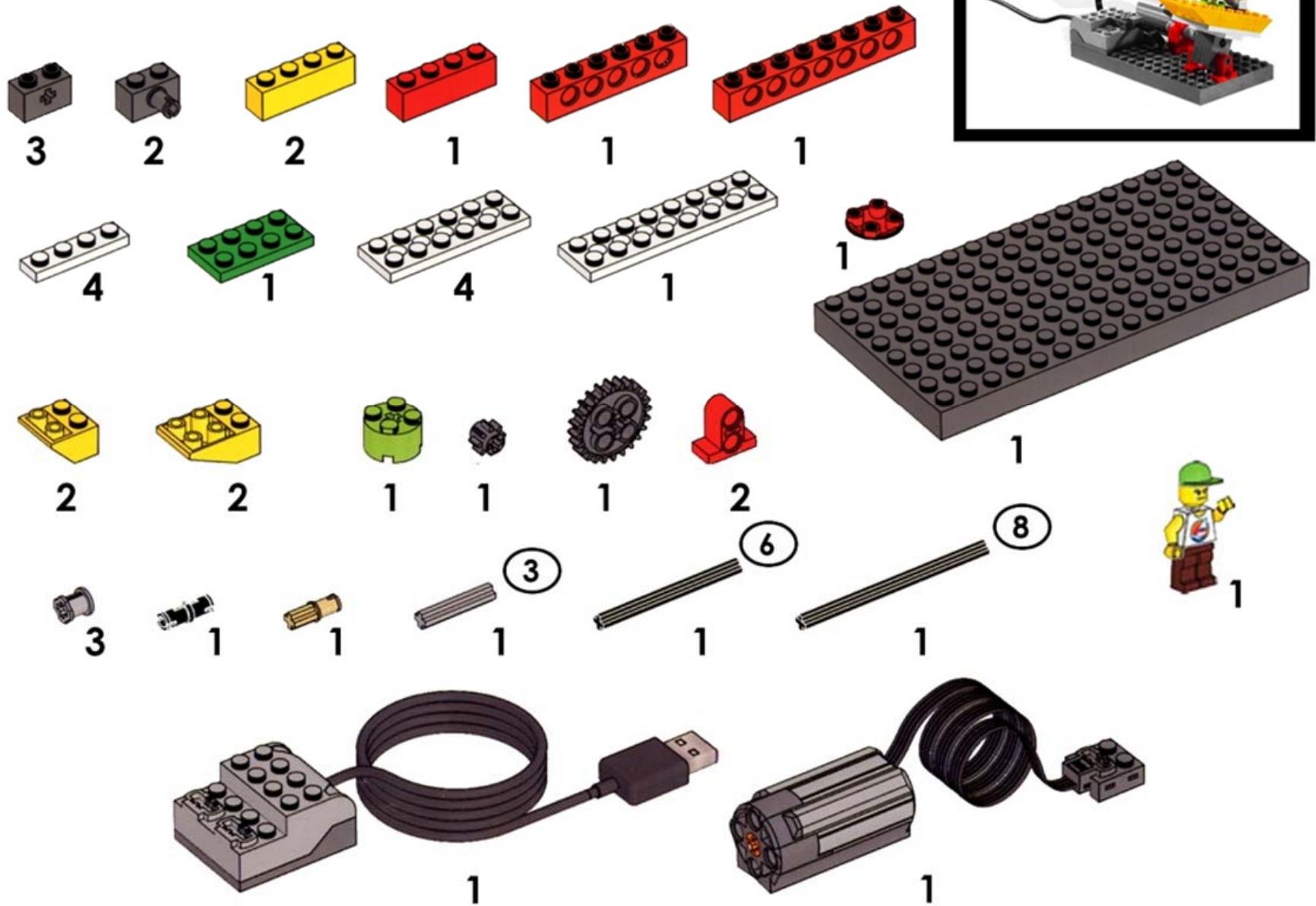

1 brick
8 X 16



1 USB hub



1 plate 2 X 8



1 red beam
1 X 4

1

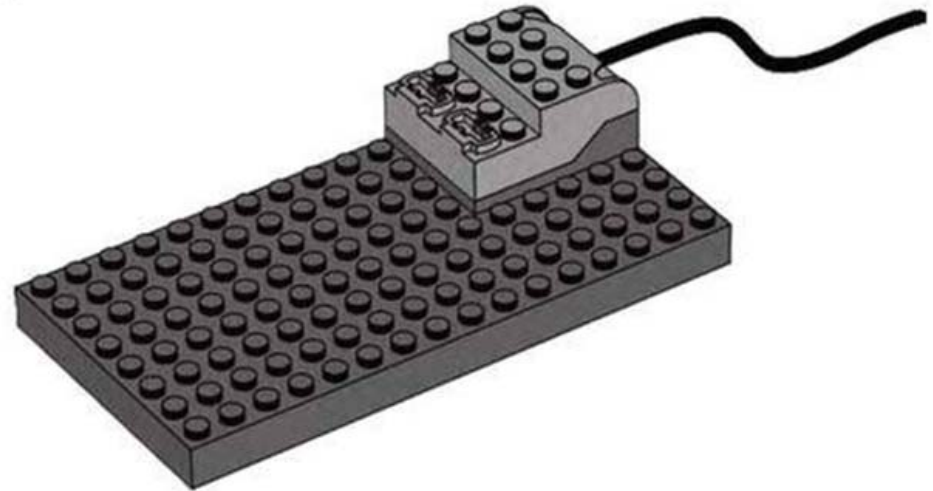

2

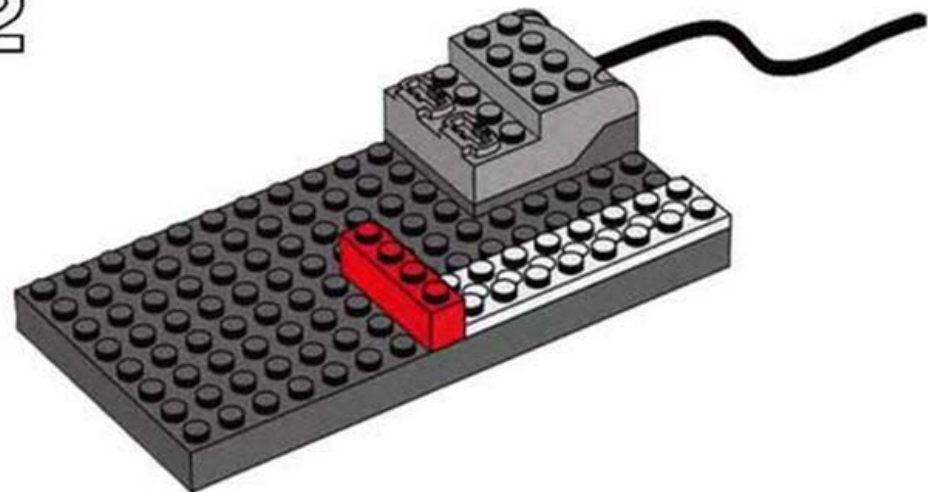

1 motor



1 red beam
1 X 6



3

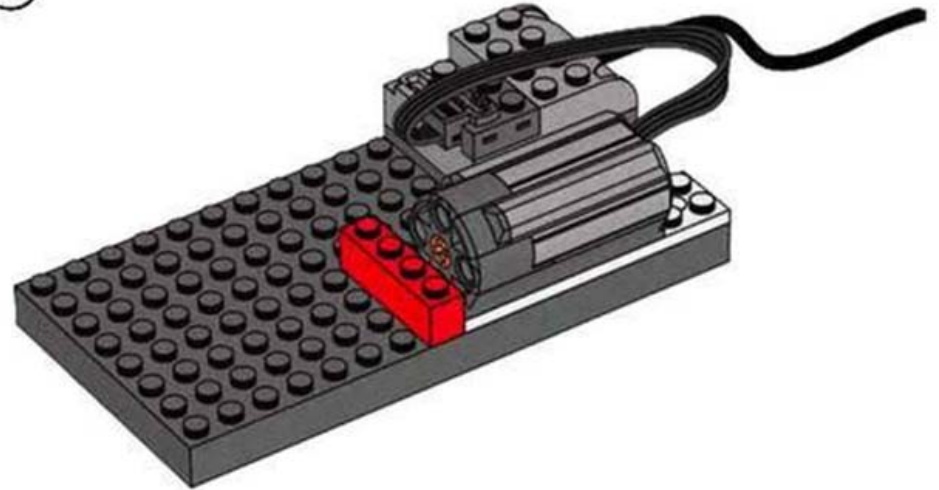

4

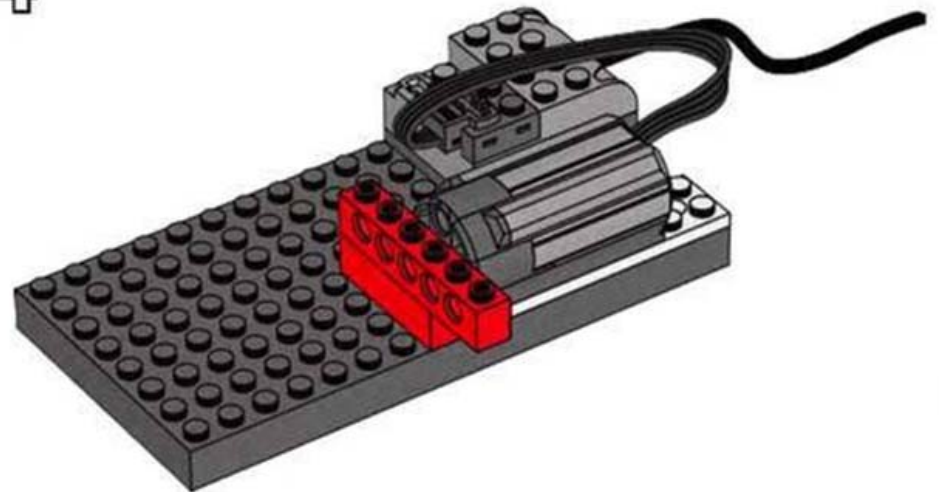

1 axle, 3-module
1 connector peg with axle

5

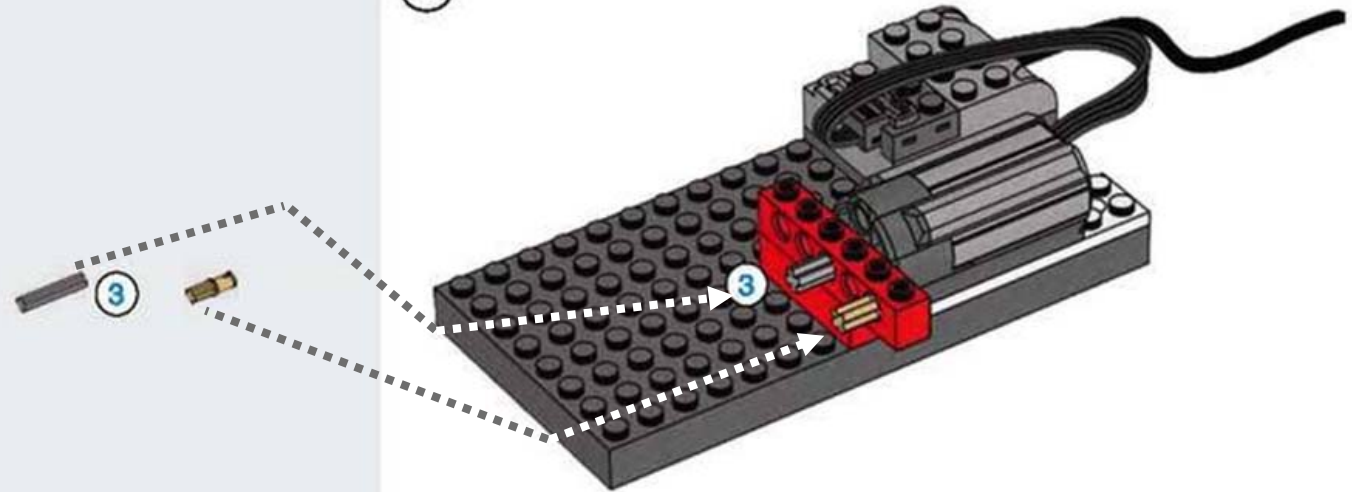

6

1 gear, 8 tooth
1 gear, 24-tooth

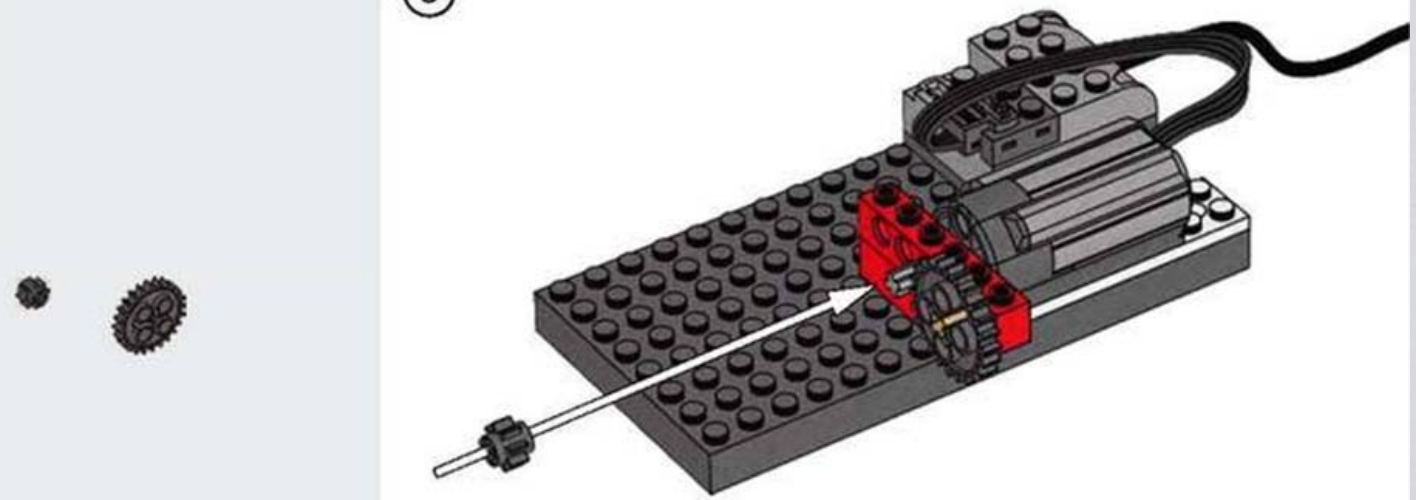



7

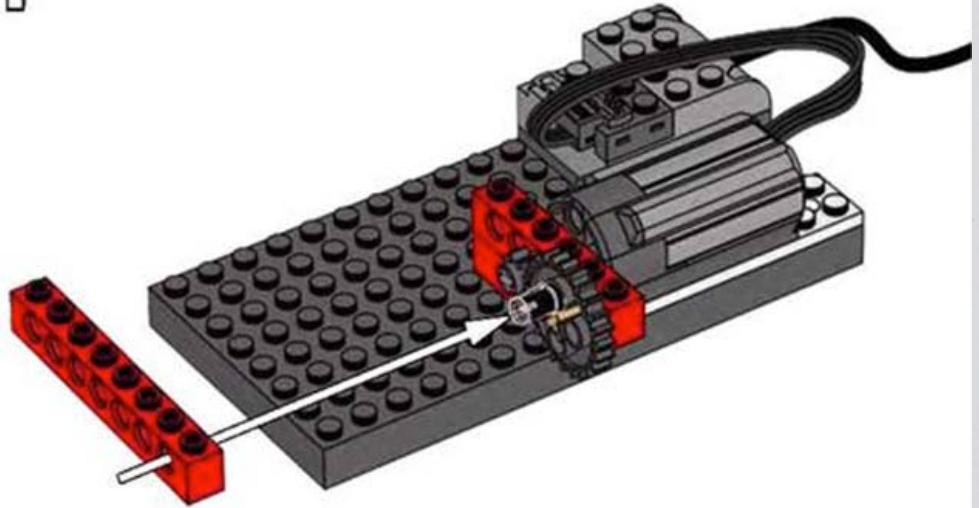

8



1 connector peg with friction
1 red beam
1 X 8

1 skid plate
1 beam with connector peg
1 X 2

9



1 beam with connector peg
1 X 2



10



2 beams with plate, 2-module

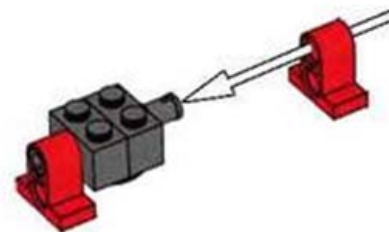

11

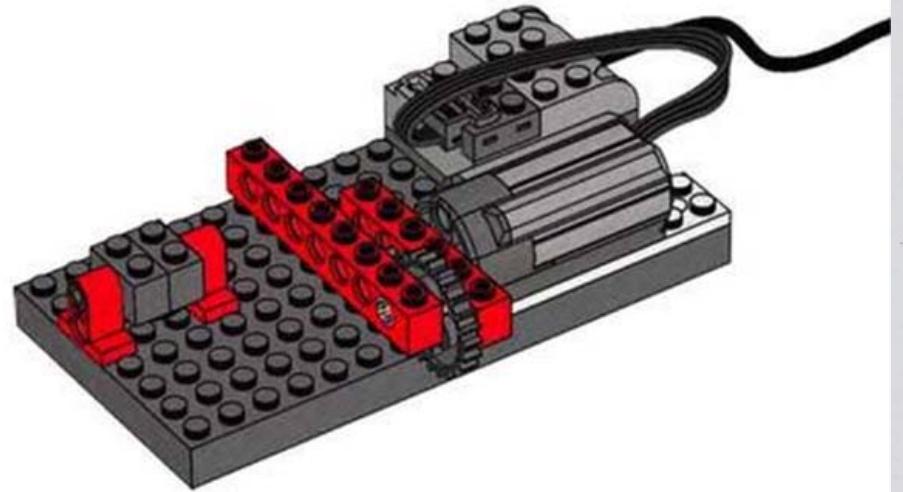
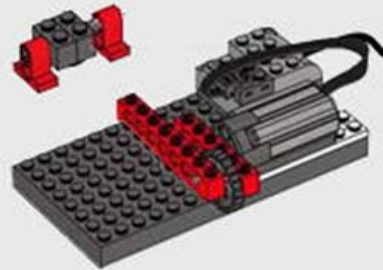

12



2 grey beams with crosshole
1 X 2

1 axle, 6-module

2 bushings



13



14

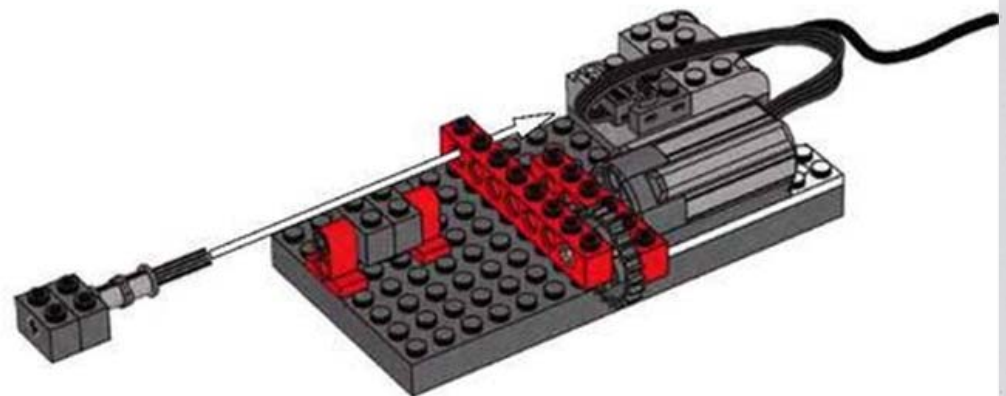

1 bushing



2 plates
1 X 4



15

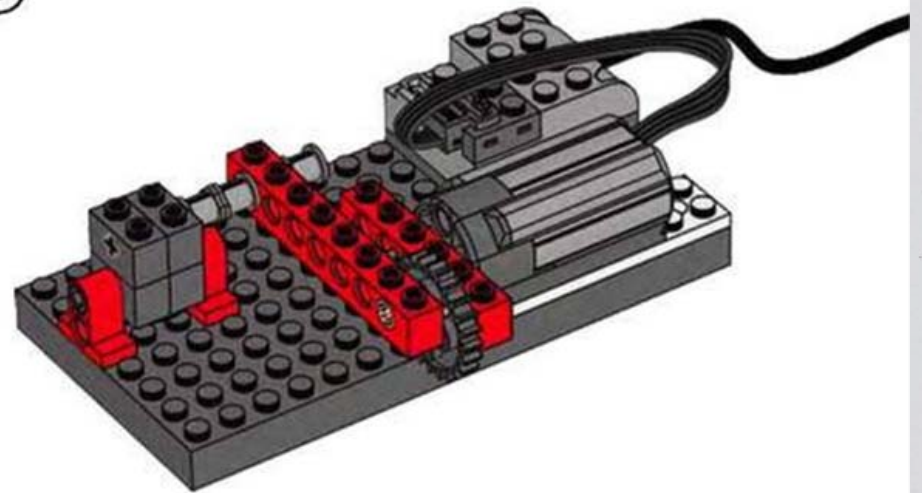

16



17

2 plates
2 X 6

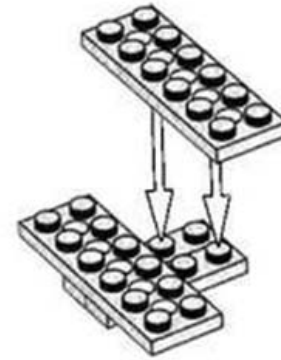

18

1 plate
2 X 4



19



2 roof bricks, inverted
2 X 3



20

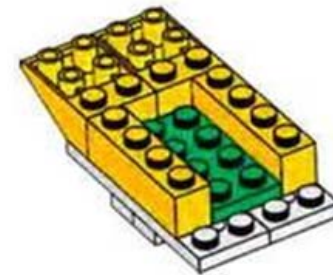

2 yellow beams
1 X 4



21

2 roof bricks, inverted
2 X 2

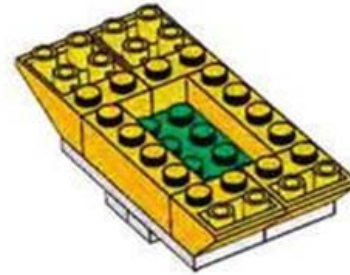

22

1 round brick
2 X 2



1 axle, 8-module



1 boy-figure



23



1 grey beam with crosshole
1 X 2



24



25

2 plates
2 X 6

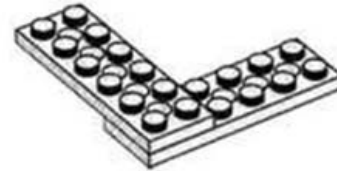

26

2 plates
1 X 4

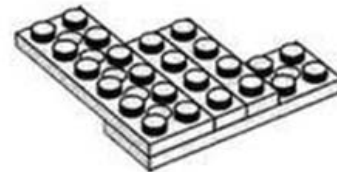

Well
Done!

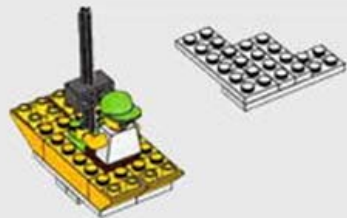

27

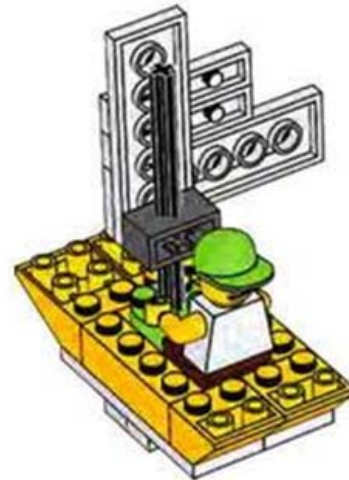

28

