



# Giant Escape

## Model 11

Source : Plan et images de LEGO Education  
Modification et bonification des plans par le Service national du RÉCIT à l'éducation préscolaire  
Translation: LEARN-RÉCIT  
February 2012

# Giant Escape, Model 11

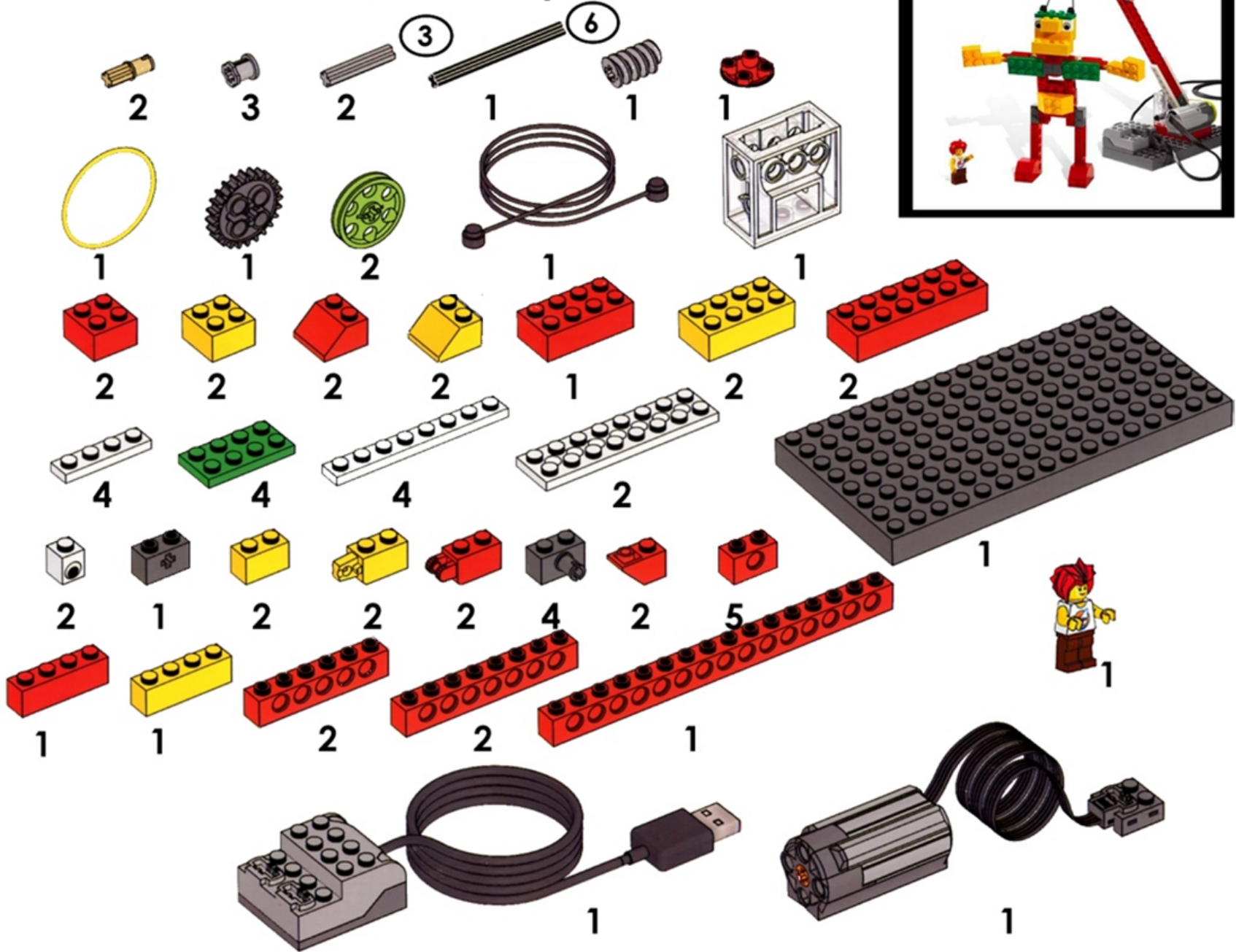



1 brick  
8 X 16



2 red bricks  
2 X 6



1 gear box  
1 worm gear



1

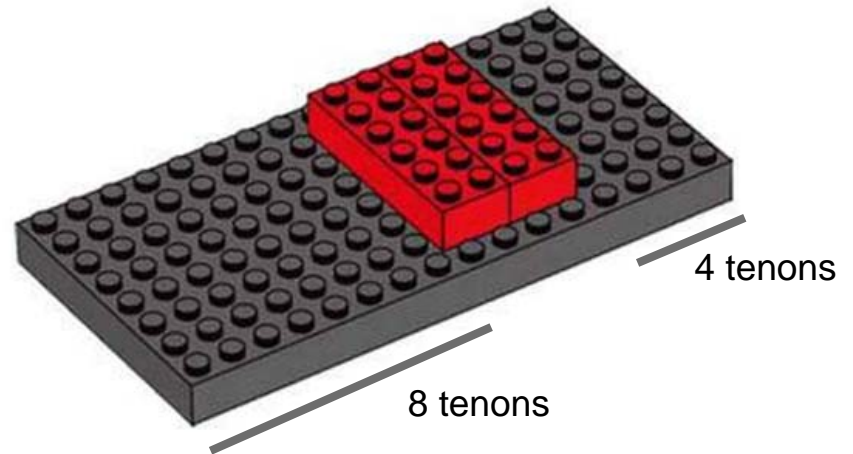

4 tenons

8 tenons

2

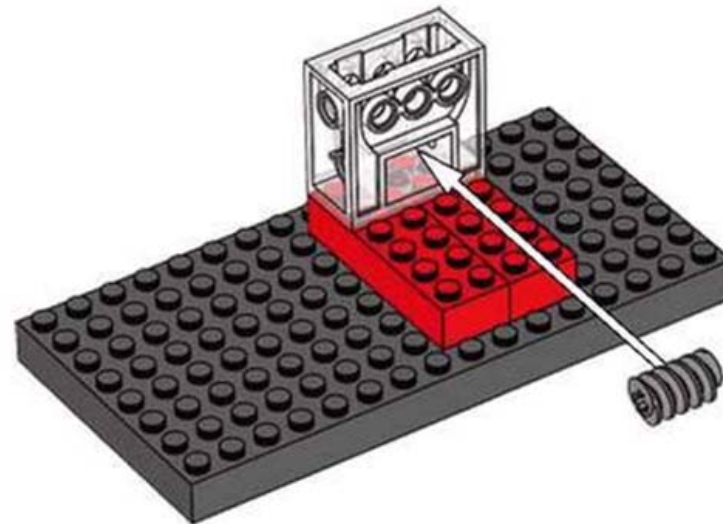



1 axle, 6-module



1 hub  
1 bushing



3

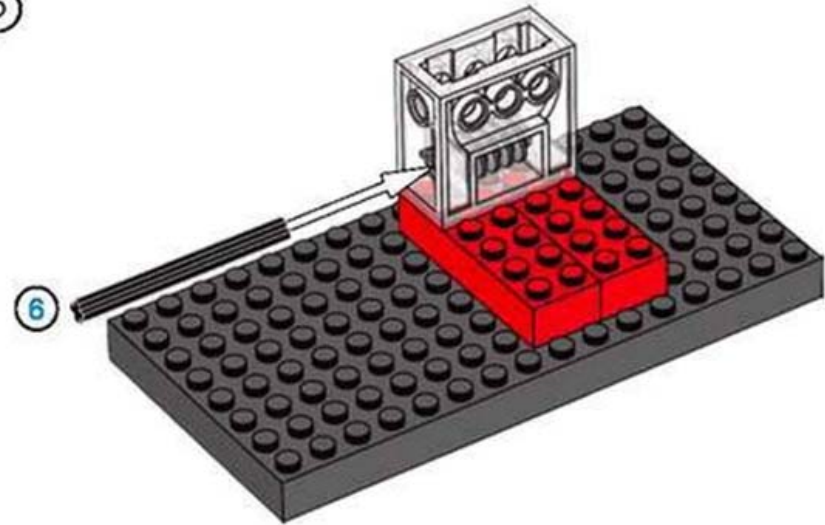

4

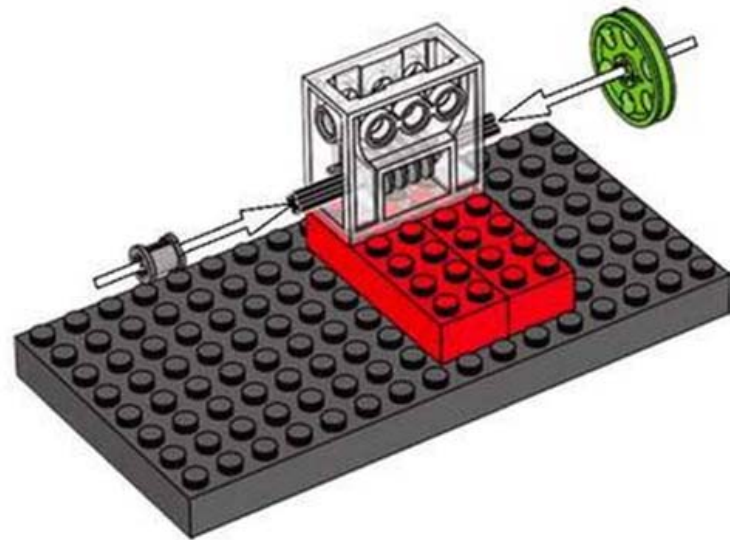

1 gear, 24-tooth



1 axle, 3-module



1 USB hub



5

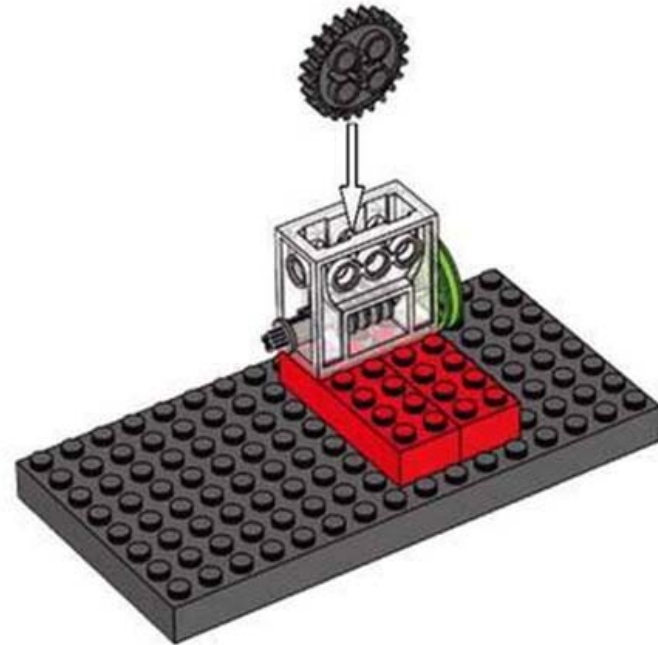

6

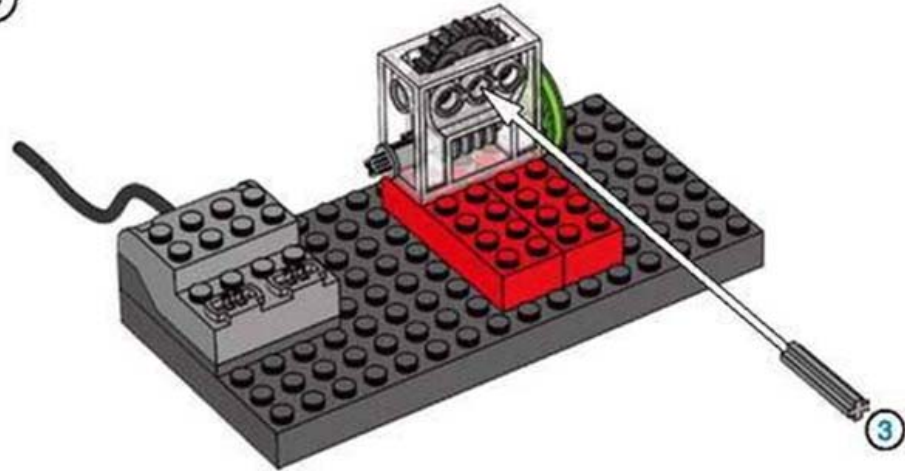

7

1 plate  
2 X 8

1 beam with crosshole  
1 X 2



8

1 beam with crosshole  
1 X 2

1 beam  
1 X 16

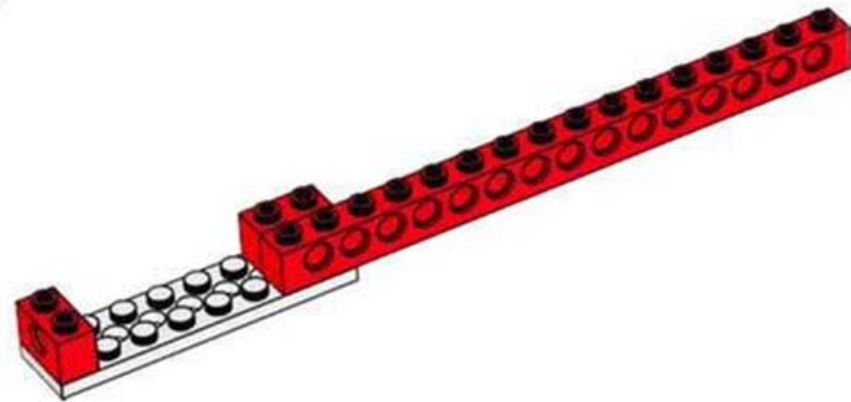

9

1 plate  
2 X 8  
2 connector pegs with axle

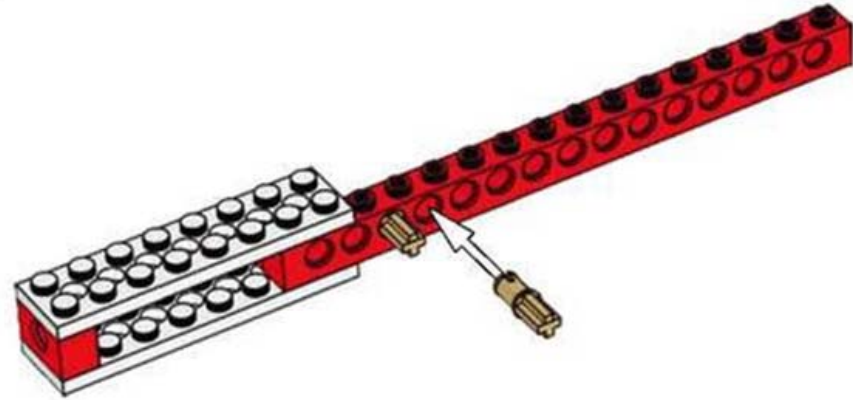

10

2 bushings  
1 plate  
1 X 8

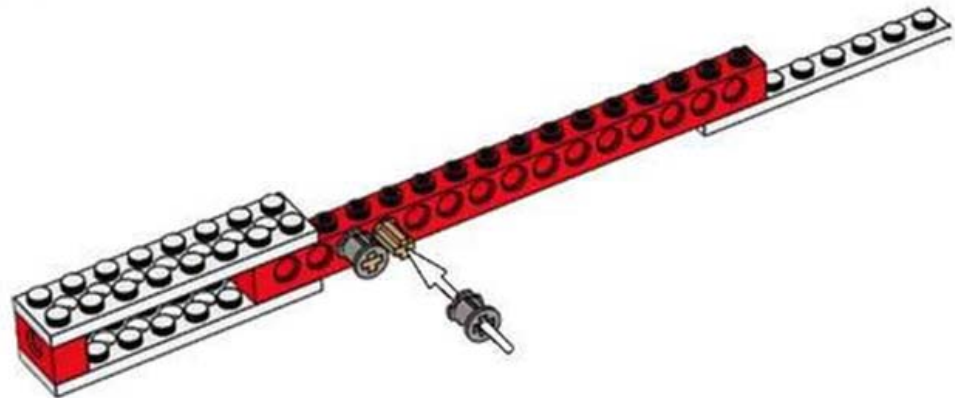

1 grey beam with crosshole  
1 X 2  
1 red beam  
1 X 4



11

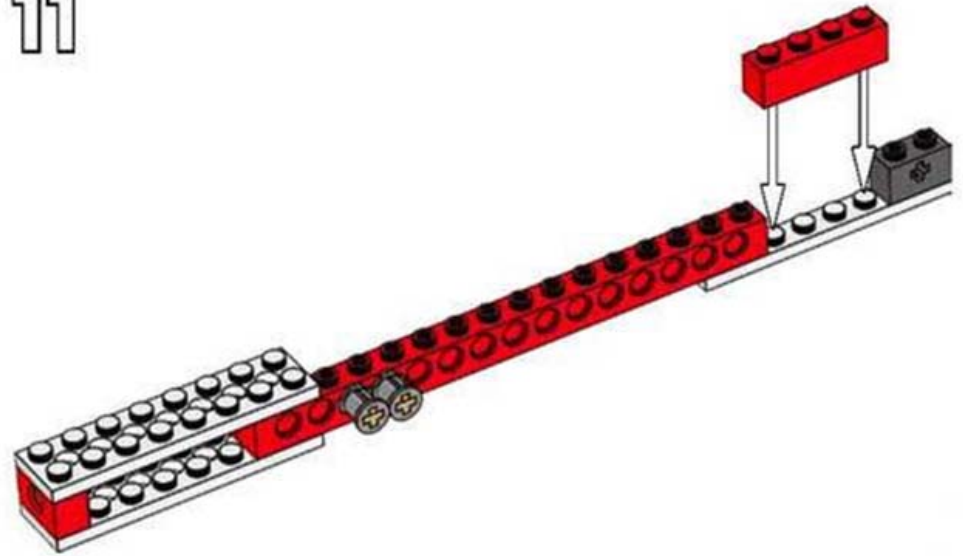

1 black cord with connectors  
1 plate  
1 X 8



12



\*\*\* Il est recommandé de croiser la  
corde entre les deux manchons.



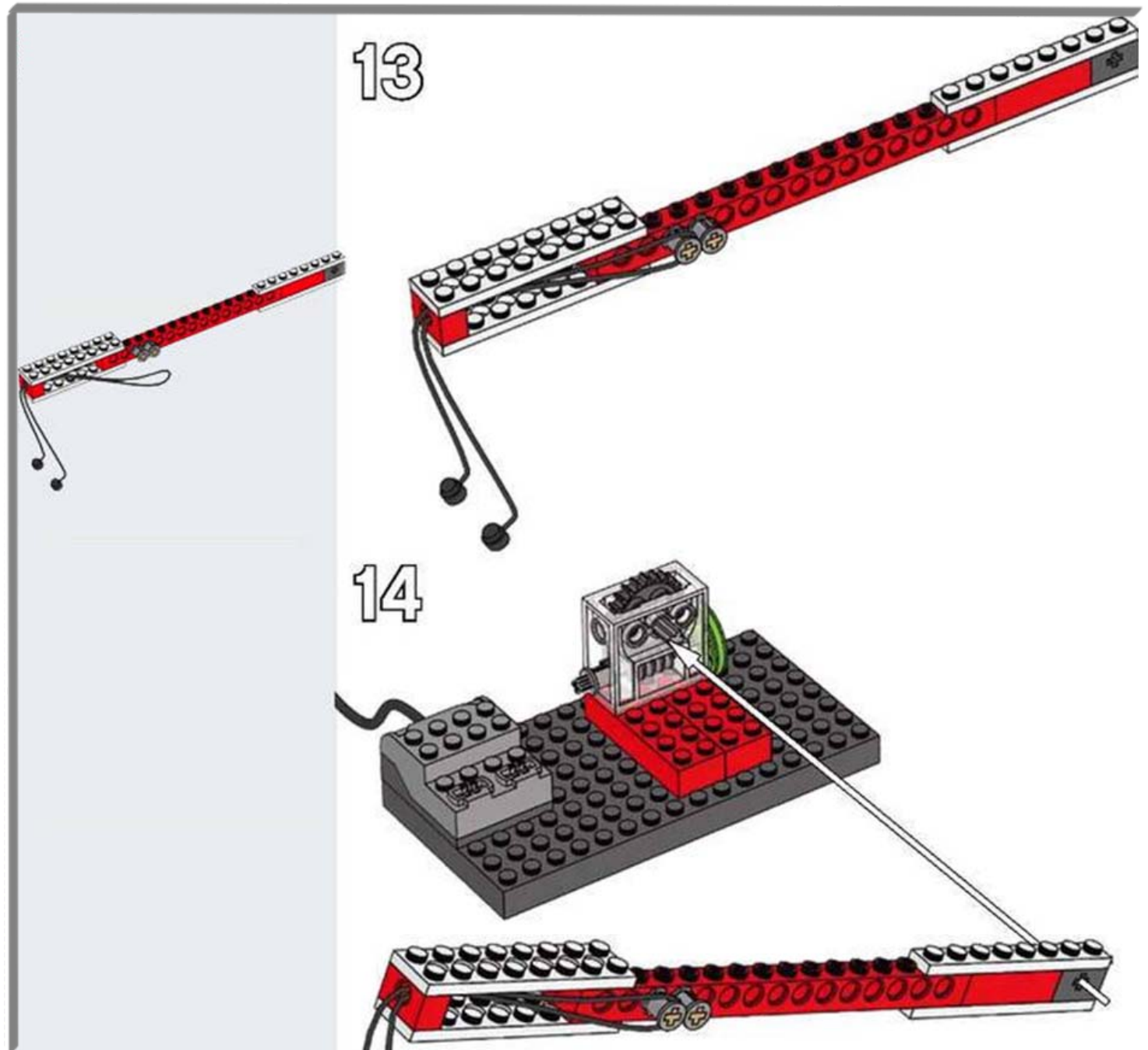

1 axle, 3-module

1 hub

1 motor



15

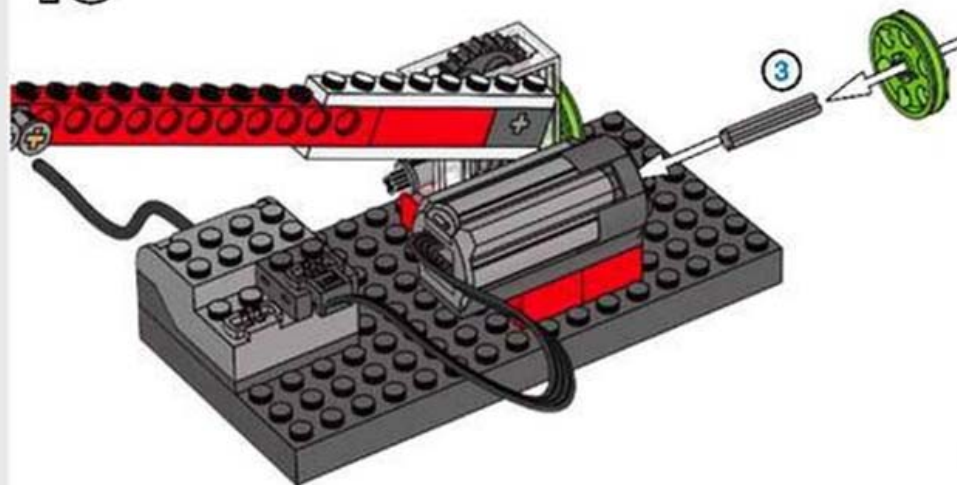

1 belt



16

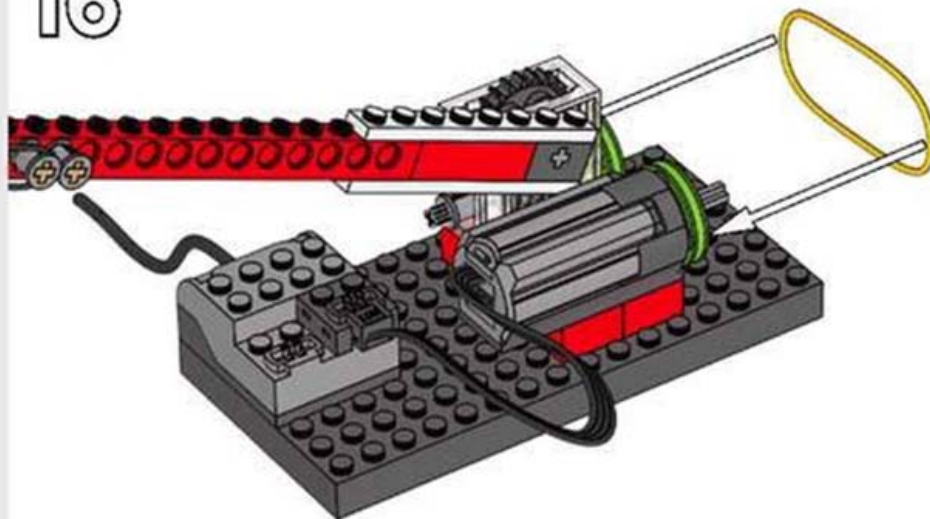

17



1 yellow brick  
2 X 4  
1 red beam with crosshole  
1 X 2



18



1 yellow brick  
2 X 4

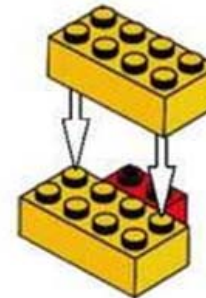

19

2 yellow beams  
1 X 2  
1 yellow beam  
1 X 4

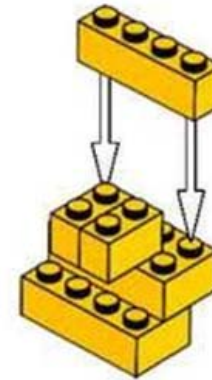

20

2 beams with eye  
1 X 1

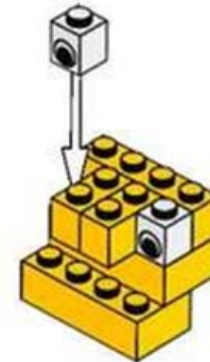



21

1 green plate  
2 X 4



22

2 red beams with crosshole  
1 x 2

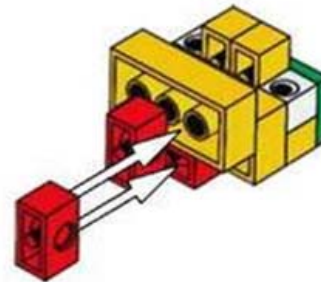

23

2 beams with connector peg  
1 X 2

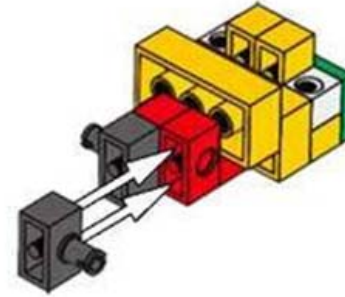

24

1 skid plate

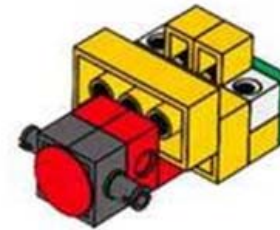

25

2 red beams  
1 X 8

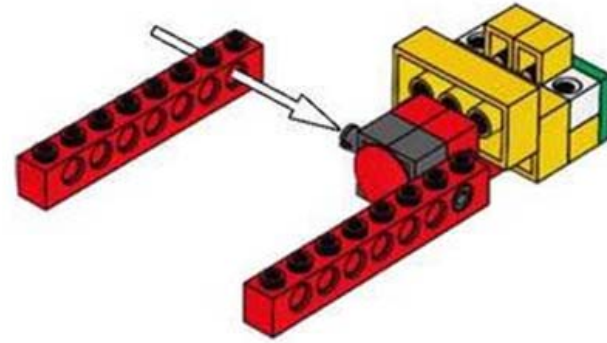

26

1 green plate  
2 X 4

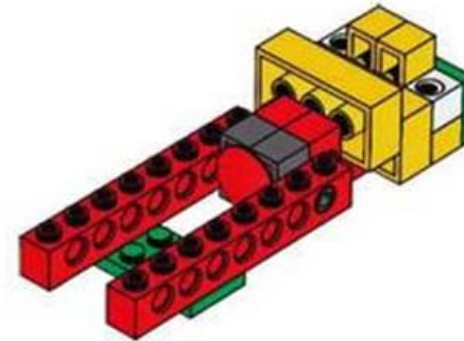

27

1 red brick  
2 X 4

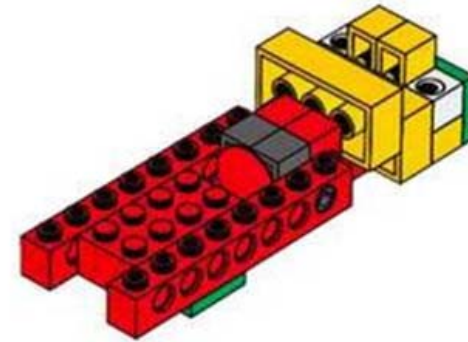

28

2 roof bricks  
2 X 2

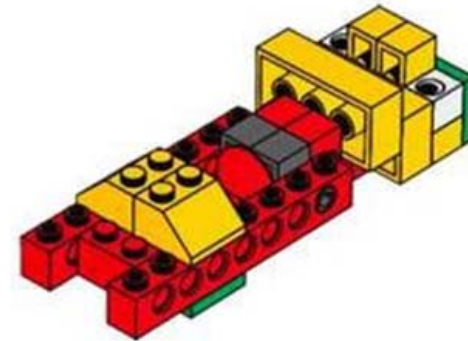



29

2 white plates  
1 X 4

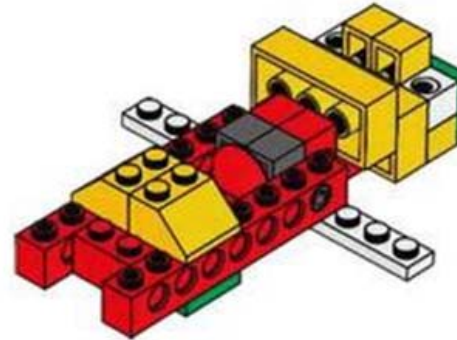

30

2 red hinges  
1 X 2

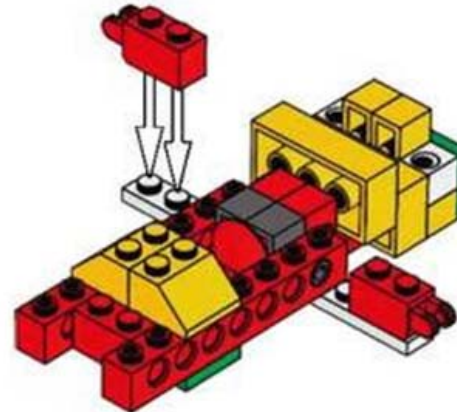

31

2 green plates  
2 X 4

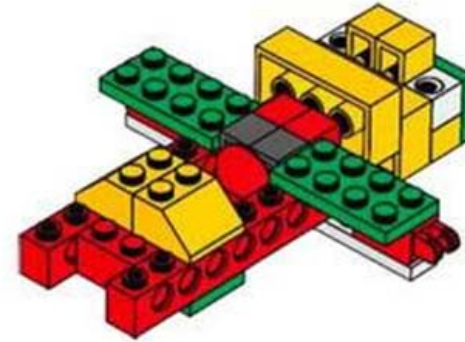

32

2 white plates  
1 X 4



2 yellow hinges  
1 X 2

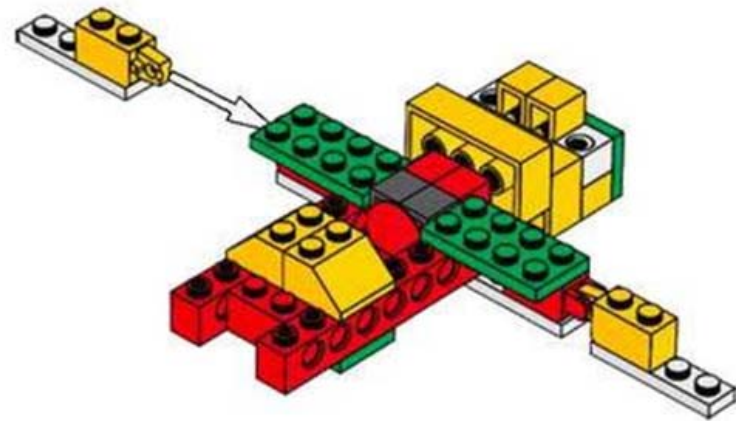

33

2 yellow bricks  
2 X 2

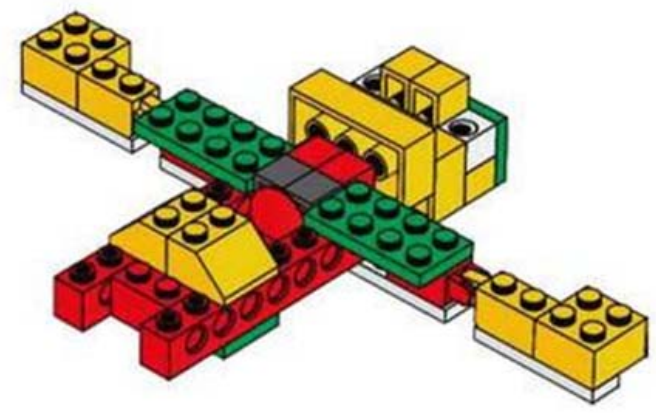

34

2 white plates  
1 X 8



2 beams with connector peg  
1 X 2

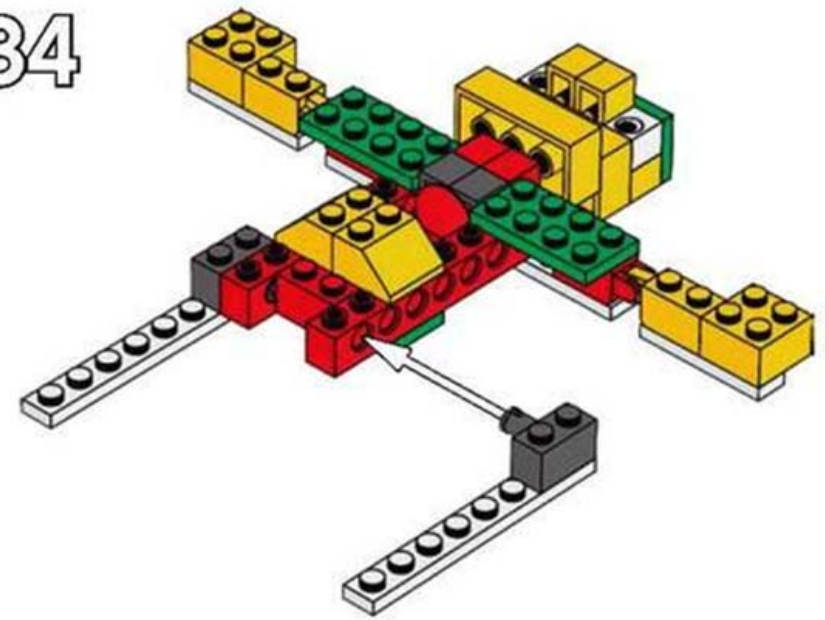

2 red beams  
1 X 6



35

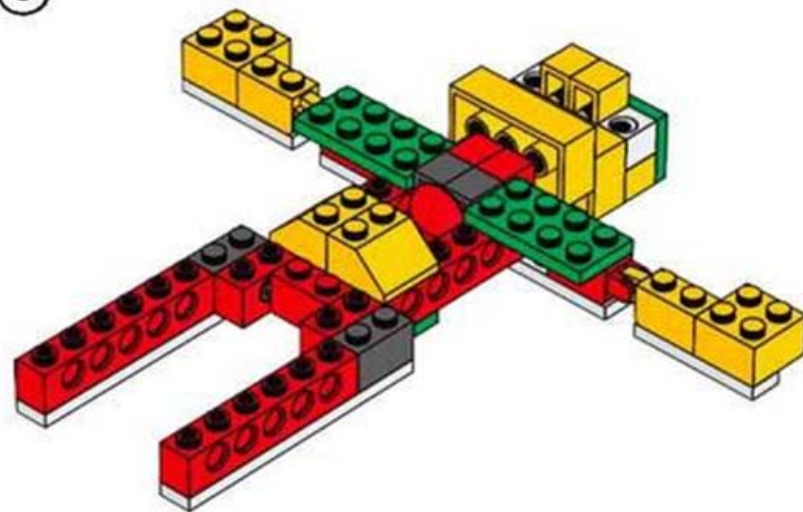

2 red bricks  
2 X 2



36

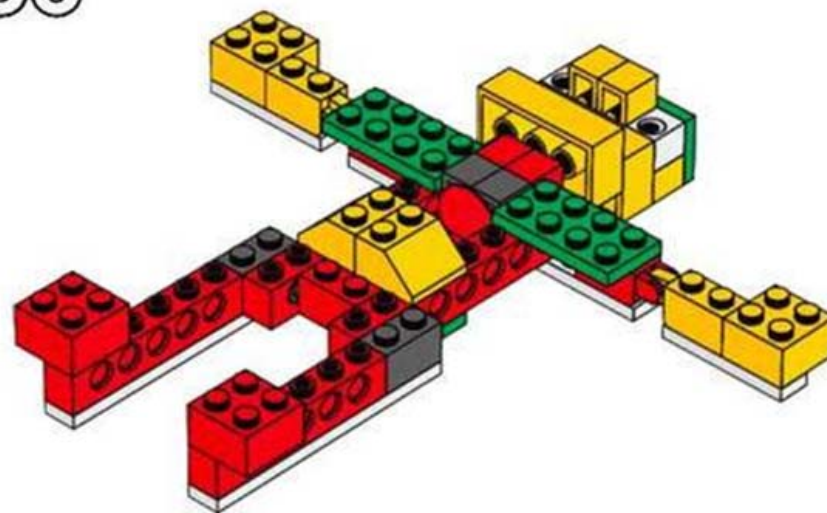



37

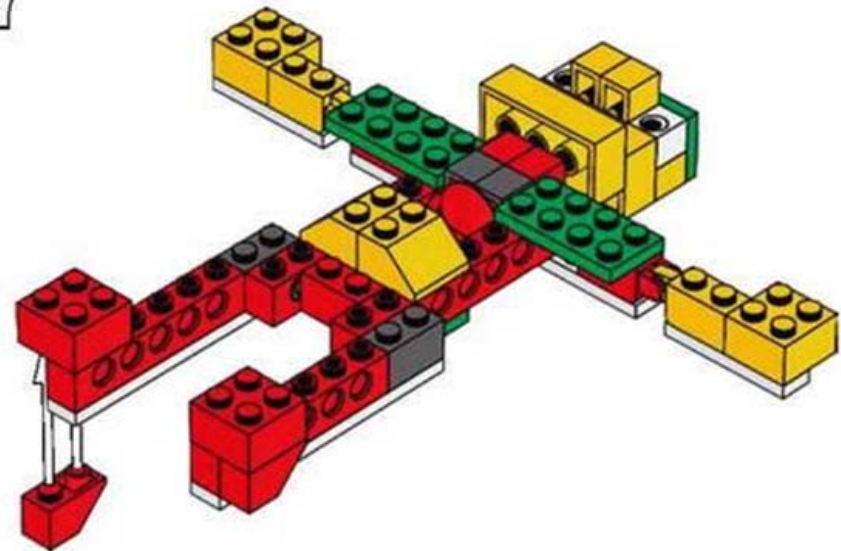

2 roof beams, inverted  
1 X 2



38

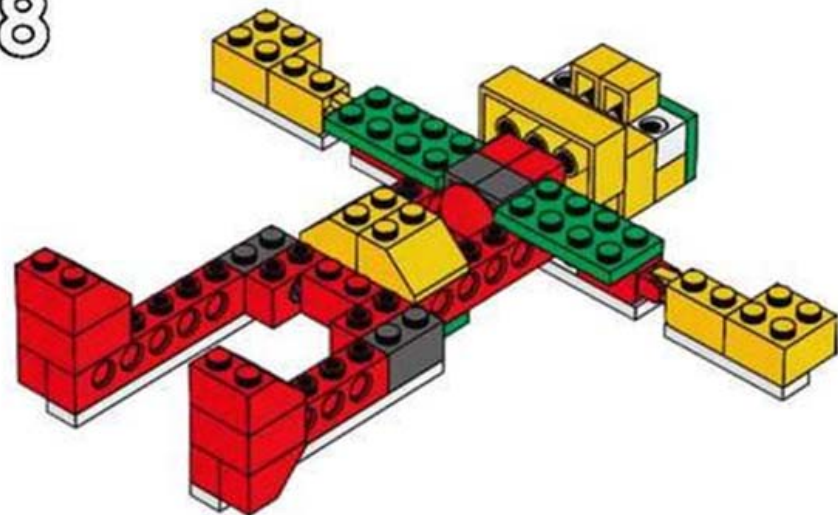

2 roof bricks, inverted  
2 X 2





39

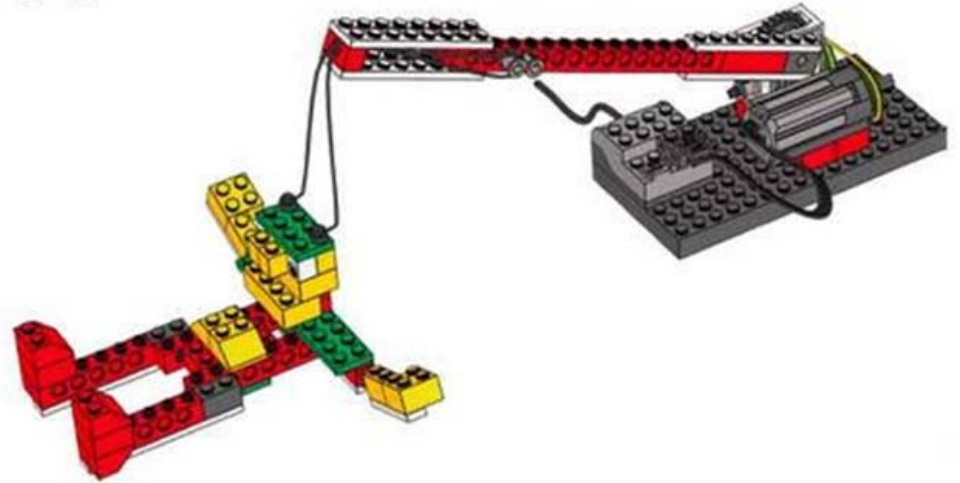

40



1 girl-figure

Well  
Done!



41

